

**University of Utah**  
**Electrical & Computer Engineering Department**  
 ECE 3600 Lab 3  
**3-Phase Synchronous Motor & Generator**

Based on a lab by: D. K. Gehmlich  
 A. Stolp, 11/08, 10/12, 10/4/22, 3/9/23

**Objectives**

1. Hook up the synchronous machine as a motor ( $\Delta$ ) and observe the effects of varying the field current.
2. Hook up the synchronous machine as a generator (Y) and drive it with a DC motor.
3. Synchronize the generator to the 3-phase line and bring it "on line".
4. Observe the effects of adding torque with the DC motor and of varying the field current of the synchronous generator.

**Equipment and materials to be checked out from stockroom:**

See the last page of this lab. Ask TA for pre-printed check-out list and check out those items.

**Motor**

Note: you may wish to check off the steps below as you complete them.

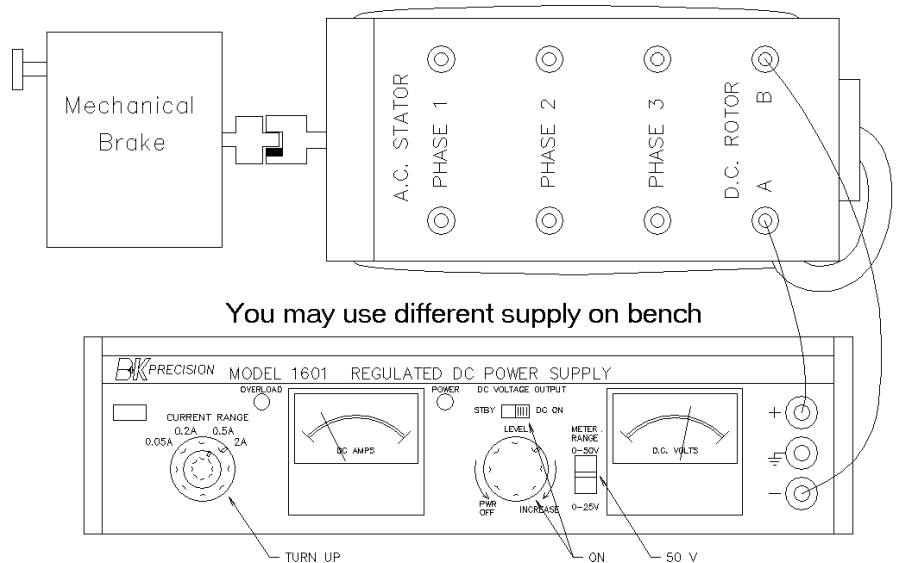

1. Turn the knob on the mechanical brake counter-clockwise to loosen up the brake.

2. Mount the 3-phase synchronous motor and the mechanical brake on the motor rack. Give them plenty of slack at the coupling.

3. Hook a power supply to the D.C. ROTOR (A B) connections. Polarity is not important. These connections will not change throughout this lab.

4. Turn off the 3-phase line breaker and hook up the 3-phase synchronous motor to the 3-phase lines (black, red, & blue) in  $\Delta$ . Pay no attention to the connector colors of the motor.

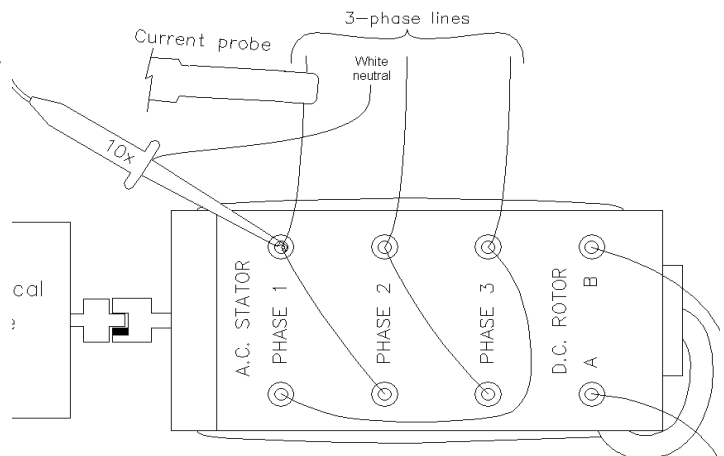

5. Hook Ch1 of the scope up to observe one of the line-to neutral voltages (a bare banana plug may be helpful here). Connect the scope ground to the 3-

phase neutral (white). **(Note: never-ever-ever... hook a scope ground to anything other than ground or neutral.)**

6. Turn on the Hantek current probe to the middle (1mV/10mA) position (replace battery if no pwr light). Hook it to Ch4 of the scope. Clamp it around the phase-1 line, with the trigger at the bottom. As always, make a drawing and comment in your notebook.

7. Turn the DC power supply on and turn it up to 30 V. (Note: If the current knob isn't turned up enough, the voltage knob won't work.)

8. Switch on the 3-phase breaker and run the motor.

9. Observe the voltage and current on the scope. Note that there is a large 6<sup>th</sup> harmonic on the current waveform, this is normal for our particular motors. Apply some load to the motor with the brake, that will make the current go up. Back off if the current gets "squirrely" or the motor sounds weird. Try to smooth out the current wave to its fundamental wave in your mind or on paper to estimate the phase relationship between the voltage and current. (If the two waveforms are not close to being in phase, first verify that neither scope channel is inverted. Turn over the current probe if there's still a problem.) Make a sketch of the voltage and current in your notebook.

10. Vary the excitation (field) voltage (B&K or other DC supply) and observe the effect on this phase relationship. Do this for under-excitation and over-excitation. Sketch the waveforms and find the approximate phase angle (I relative to V) for each case. Draw an approximate phasor diagram for each case.

11. Do your best to find the excitation voltage (and current) to get a power factor of 1. Record the DC V and I values.

12. Switch off the 3-phase breaker and the DC power supply. Leave the DC supply-to-field connections in place, but remove all the 3-phase wires.

13. Clear away the current probe (**and switch it OFF**) and the scope probes you've been using. From here on you'll use the BNC-to-banana plug (or clip leads) leads as scope probes.

## Generator

1. Replace the brake (be careful, it may be hot) with the DC motor on the motor rack to drive 3-phase synchronous machine. Give the motors plenty of slack at the coupling. You may need to use a shim under the DC motor to make the two line up well.

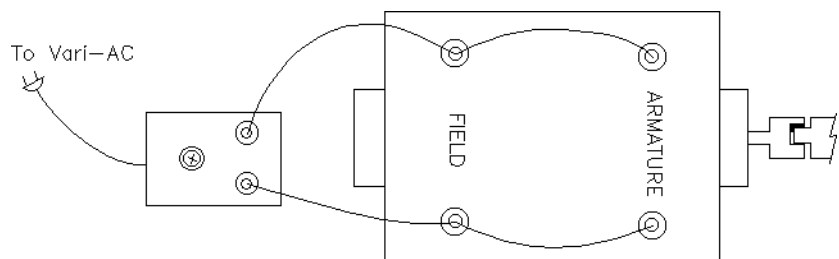

2. Turn off the Vari-AC and plug it in. Plug the Rectifier box into the Vari-AC and hook the output to the DC motor. Polarity is not important. Switch on the Vari-AC and turn it up to make sure that you can drive the AC motor smoothly. Turn it back down.

3. Turn off the 3-phase breaker on your bench and wire the 3-phase lines to the left-most connections of the synchronizing box (shown at right). Wire the AC motor in Y to the right side connections of the box.

4. Hook two of the neutrals from the motor to the center neutral of the box and one to the "CURRENT N" connection. This will be your current measurement position and you will hook it to Ch4 of the scope later.

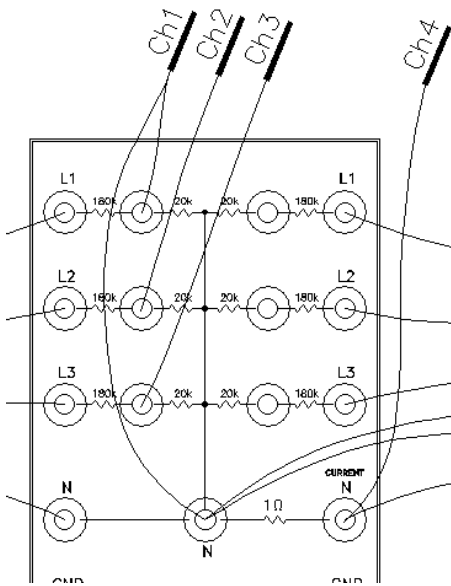
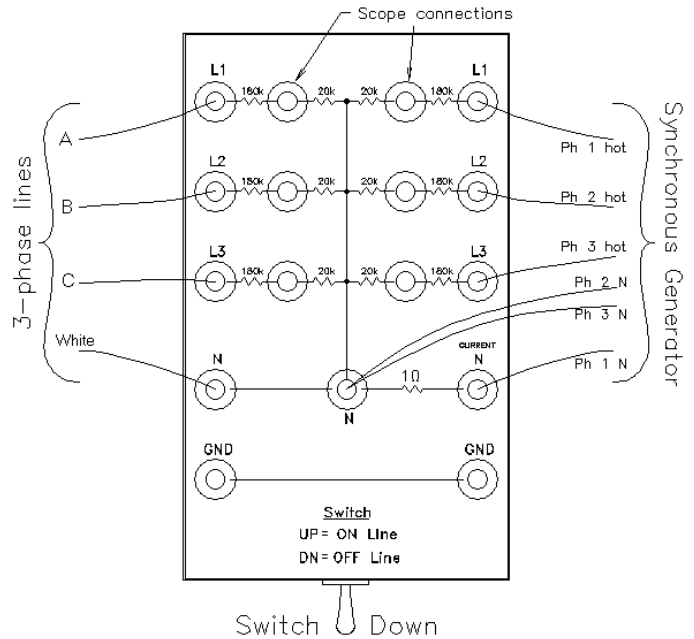

5. Your wire box should contain 4 BNC-to-Banana cables for the scope. (If not, use BNC-to-clip leads with some bare banana plugs.) Hook up the scope channels as shown (only one neutral connection is needed).

6. Make sure the switch on the synchronizing box is in the down (off line) position.

7. Set the scope to trigger on Ch1 and view channels 1-3. Turn on the 3-phase breaker. All 3 channels should be set up the same way (volts/div, probe setting, no inversion).

L1, L2 and L3 should make an ABC sequence (yellow, blue, red on the scope). Note the color sequence, especially if it's different.

8. Turn off the 3-phase breaker, if you wish. Move the scope channels as shown at right.

9. Turn on the DC power supply hooked to the 3-phase machine. Turn on the 3-phase breaker. Nothing should move or make noise, if something does, make sure the switch on the synchronizing box is in the down (off line) position.

10. Turn up the Vari-AC and spin-up the generator with the DC motor.

11. The scope should now show 3 waveforms in the same color sequence as before (step 7). (Note that there is a large 12<sup>th</sup> harmonic on the waveforms, this is normal for our particular machines.)

12. If you don't see the same color sequence, change generator connections or the DC motor rotation direction as necessary to get the same sequence. This is **VERY Important**.

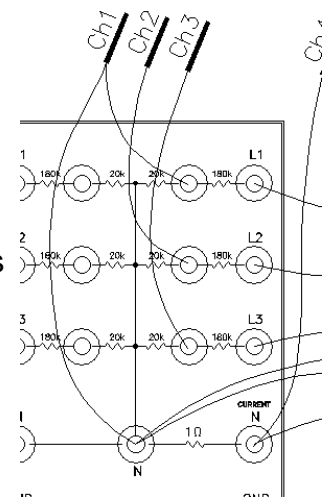

Go back to the earlier scope connections to double-check. If you have any doubts about what you just did, **ask the TA to check your sequences before proceeding**. If they are wrong, you **could destroy the synchronous machine**. 3-phase synchronous machines of this size are not used in the field. These were specially wound for the University of Utah many years ago. We only have 4 left and they would be **very expensive, if not impossible** to replace.

13. Move Ch1 & Ch2 so as to display a line phase and a generator phase on the scope at the same time. Set the scope to trigger on Ch1 and view channels 1 & 2.

14. Adjust the speed of the DC motor so that the generated frequency is 60Hz, to match the line waveform.

15. Set the field current so that the phase voltage magnitudes you see on the scope are the same. Try to ignore the higher-frequency harmonics on the generator voltage. Note the generator's field current and voltage.

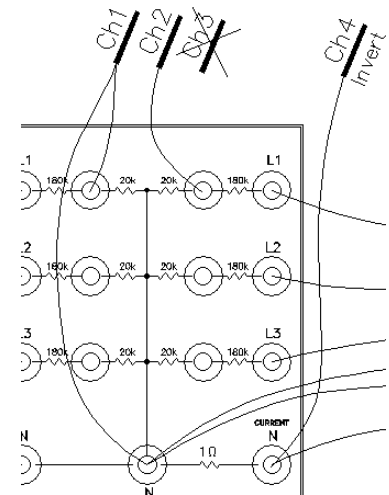

16. Wait for the two waveforms on the scope to line up and then switch the generator on line at just the right instant, when they are in phase with each other.

17. In your notebook, describe the steps to bring a generator on line. Note the setting of the Vari-AC that controls the speed of the DC motor.

18. View Ch 4 to observe a phase current at the “CURRENT N” connection. Because of where and how this current is measured, you will need to Invert this waveform at the scope. (Hit the CH4 button and find the “invert” button to the right of the screen.) There should be little or no current.

14. Try to increase the speed of the DC motor. The DC motor will not increase the speed, but it will apply a torque to the AC generator which will push current to the grid. (Back off if the current gets “squirrely” or the motor sounds weird.) The generator is now converting the input mechanical power into electrical power going onto the line.

15. Sketch the current waveform. Note the harmonics. What is the dominant harmonic?

16. Check to make sure you are measuring the current and voltage of the same phase and that the current measurement is inverted at the scope. Look at the voltage and current on the scope. Try to smooth out the current wave to its fundamental wave in your mind or on paper to estimate the phase relationship between the voltage and current. Do the waveforms make sense, especially with respect to phases? Explain in your notebook.

17. Vary the DC excitation (field) voltage (and thus current) and observe the effect on this phase relationship you see on the scope. Do this for under-excitation. Sketch the waveforms and find the approximate phase angle (I relative to V). Draw an approximate phasor diagram.

18. Repeat for over-excitation.

19. Do your best to find the excitation voltage (and current) to get a power factor of 1. Record the DC field V and I values.

20. Turn up the Vari-AC far enough to “pull-out” the generator and then back off enough that the phase current settles back down. Increase the field current to bring the phase current back in phase with the voltage waveform. Repeat this paragraph 1 or 2 more times. Do your best to determine how much power you are generating from the scope waveforms.

21. Describe the effect of excitation on the pull-out” behavior.

22. Switch the generator off line and note how much the system speeds up. What does this say about the torque between the two machines when the generator was on line?

23. Turn off the 3-phase line breaker, the DC power supply and the Vari-AC.

### Check off, Conclude and Clean Up

Check off and conclude as always. Be sure to compare what you found in the lab to what you expect to see from theory.

**Make SURE the CURRENT PROBE is TURNED OFF** before returning it !!

NAME	
DATE	
CLASS	ECE 3600 SECTION
QUANTITY	DESCRIPTION
2	Power wire kits
1?	Power strip (may be in power wire kit)
1	Synchronizing box (see picture on p2)
1	Hantek current probe
1	AC to DC rectifier box (see picture on p2)
1	Vari-AC (Auto-transformer)
1	Motor rack
1	BOB (bucket of bolts)
1	NSH-34 DC motor
1	NNP34 3-phase synchronous motor
1?	B&K 1601 Power supply (or use power supply on bench, hooked in series configuration)

<----- A pre-printed checkout slip like this should be available from your TA, or cut this one out here.