

# Diodes Notes

ECE 2210

A. Stolp  
4/8/03,  
2/27/07

Diodes are basically electrical check valves. They allow current to flow freely in one direction, but not the other. Check valves require a small forward pressure to open the valve. Similarly, a diode requires a small forward voltage (bias) to "turn on". This is called the forward voltage drop. There are many different types of diodes, but the two that you are most likely to see are silicon diodes and light-emitting diodes (LEDs). These two have forward voltage drops of about 0.7V and 2V respectively.

silicon diode

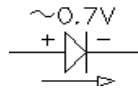

LED

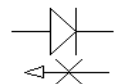
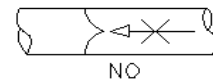
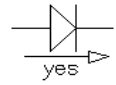
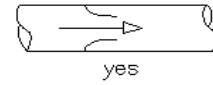
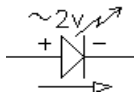

Mechanical check valve

Diode

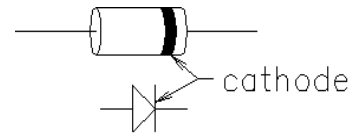

The electrical symbol for a diode looks like an arrow which shows the forward current direction and a small perpendicular line. The two sides of a diode are called the "anode" and the "cathode" (these names come from vacuum tubes). Most small diodes come in cylindrical packages with a band on one end that corresponds to the small perpendicular line, and shows the polarity, see the picture. Normal diodes are rated by the average forward current and the peak reverse voltage that they can handle. Diodes with significant current ratings are known as "rectifier" or "power" diodes. (Rectification is the process of making AC into DC.) Big power diodes come in a variety of packages designed to be attached to heat sinks. Small diodes are known as "signal" diodes because they're designed to handle small signals rather than power.

## Diodes are nonlinear parts

So far in this class we've only worked with linear parts. The diode is definitely NOT linear, but it can be modeled as linear in its two regions of operation. If it's forward biased, it can be replaced by battery of 0.7V (2V for LEDs) which opposes the current flow. Otherwise it can be replaced by an open circuit. These are "models" of the actual diode. If you're not sure of the diode's state in a circuit, guess. Then replace it with the appropriate model and analyze the circuit. If you guessed the open, then the voltage across the diode model should come out less than +0.7V (2V for LEDs). If you guessed the battery, then the current through the diode model should come out in the direction of the diode's arrow. If your guess doesn't work out right, then you'll have to try the other option. In a circuit with multiple diodes (say "n" diodes), there will be  $2^n$  possible states, all of which may have to be tried until you find the right one. Try to guess right the first time.

- 1 Assume the diode is operating in one of the linear regions (make an educated guess).
- 2 Analyze circuit with a linear model of the diode.
- 3 Check to see if the diode was really in the assumed region.
- 4 Repeat if necessary.

## Actual diode curve

The characteristics of real diodes are actually more complicated than the constant-voltage-drop model. The forward voltage drop is not quite constant at any current and the diode "leaks" a little current when the voltage is in the reverse direction. If the reverse voltage is large enough, the diode will "breakdown" and let lots of current flow in the reverse direction. A mechanical check valve will show similar characteristics. Breakdown does not harm the diode as long as it isn't overheated.

**Zener diodes** are special diodes designed to operate in the reverse breakdown region. Since the reverse breakdown voltage across a diode is very constant for a large range of current, it can be used as a voltage reference or regulator. Zener diodes are also used for over-voltage protection. In the forward direction zeners work the same as regular diodes.

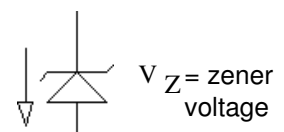

## Constant-voltage-drop model

This is the most common diode model and is the only one we'll use in this class. It gives quite accurate results in most cases.

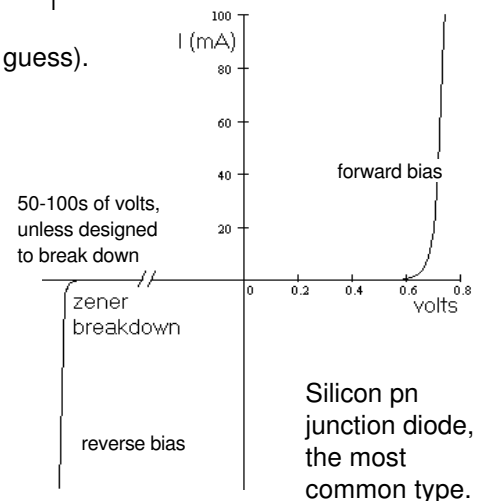
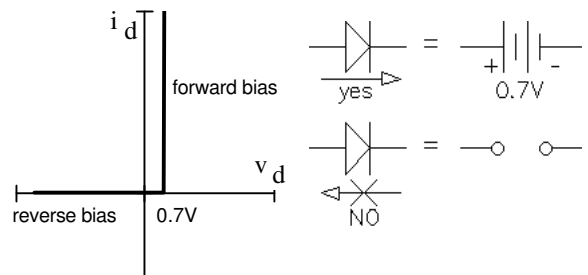

I recommend that you try some of the DC analysis in the Diode Circuit Examples handout before you proceed here.

### Diodes in AC Circuits

Diodes are often used to manipulate AC waveforms. We'll start with some triangular waveforms to get the general idea.

Diode doesn't conduct until  $v_{in}$  reaches 0.7V, so 0.7V is a dividing line between the two models of the diode.

$$\text{slope} = \frac{0.7 \cdot V}{t_1} = \frac{V_p}{t_p}$$

$$t_1 = \frac{0.7 \cdot V}{V_p} \cdot t_p$$

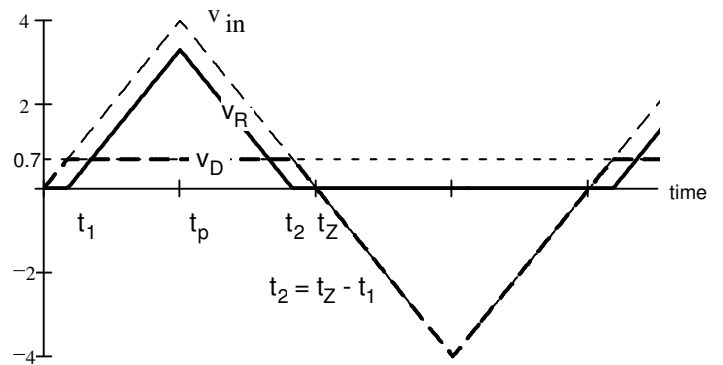
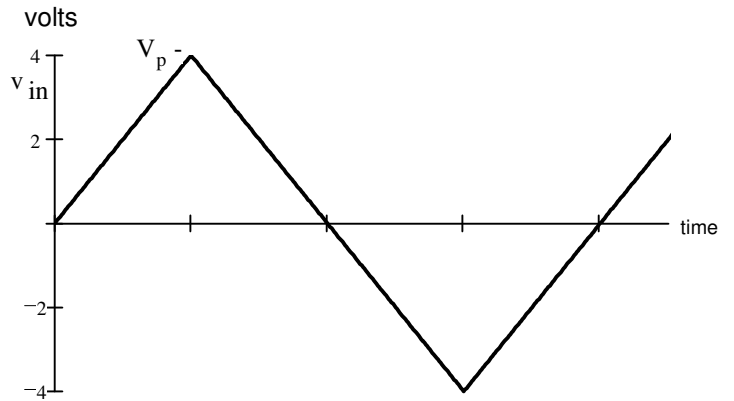
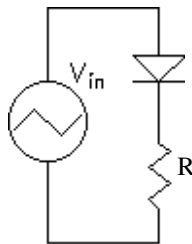

When the diode conducts, you're left with a voltage divider

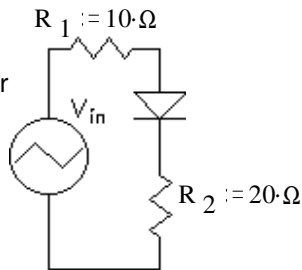

$$V_{R2\text{peak}} = (V_p - 0.7 \cdot V) \cdot \frac{R_2}{R_1 + R_2}$$

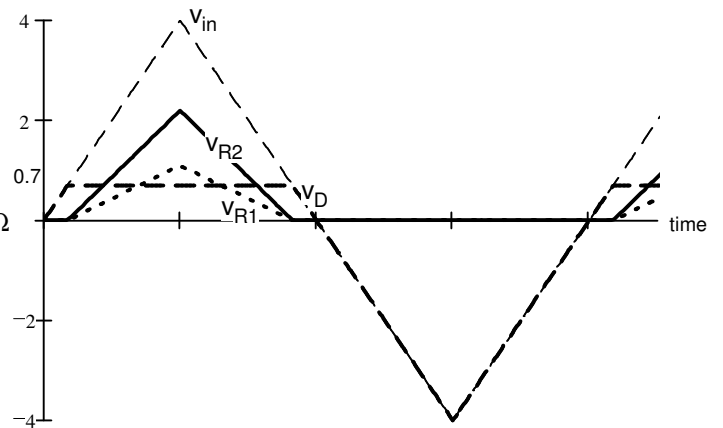

Sometimes it's helpful to figure out what the voltage across the diode would be if it never conducted (light dotted line).

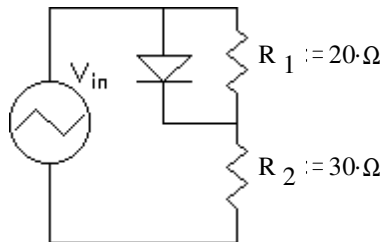

$$t_1 = \frac{0.7 \cdot V}{V_p \cdot \frac{R_1}{R_1 + R_2}} \cdot t_p$$

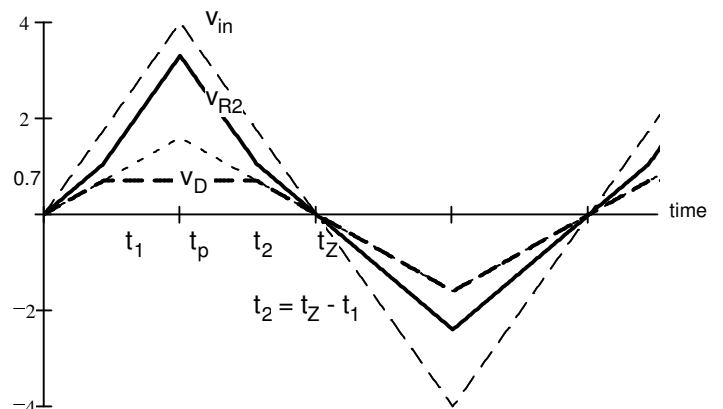

# Rectifier Circuits & Power Supplies

## Half-wave rectification

What if the input is a sine wave?

$V_{RL}$  is now DC, although a bit bumpy. Some things are better if they're bumpy, but not roads and not DC voltages.

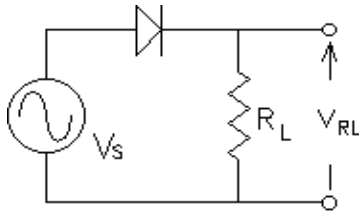

Rectification is the process of making DC from AC. Usually the AC is derived from the AC wall outlet (often through a transformer) and the DC is needed for electronic circuitry modeled by  $R_L$  here.

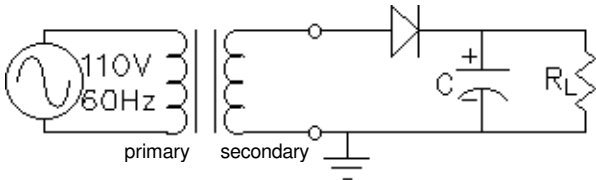

A "filter" capacitor (usually a big electrolytic) helps smooth out the bumps, although it sure looks like we could a bit bigger one here. The remaining bumpiness is called "ripple",  $V_r$  is peak-to-peak ripple

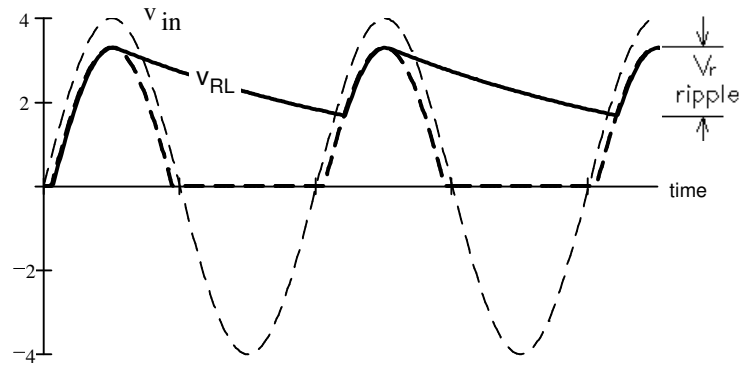
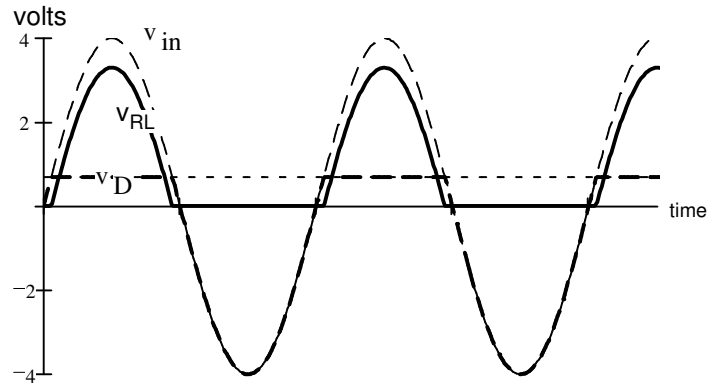

## Full-wave rectification

The "center tap" in the secondary of this transformer makes it easy to get full-wave rectification.

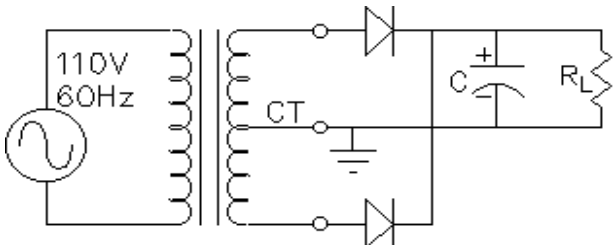

The center-tap transformer is also good for making  $\pm$  supplies

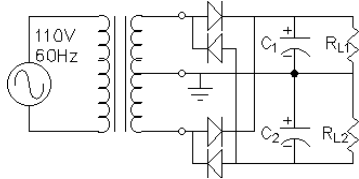

## Bridge

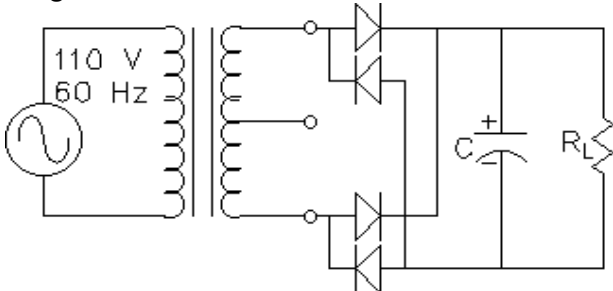

A "bridge" circuit or "bridge rectifier" can give you full-wave rectification without a center-tap transformer, but now you lose another "diode drop"

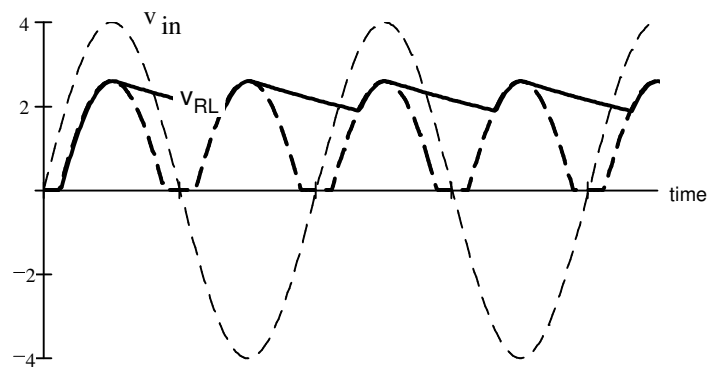
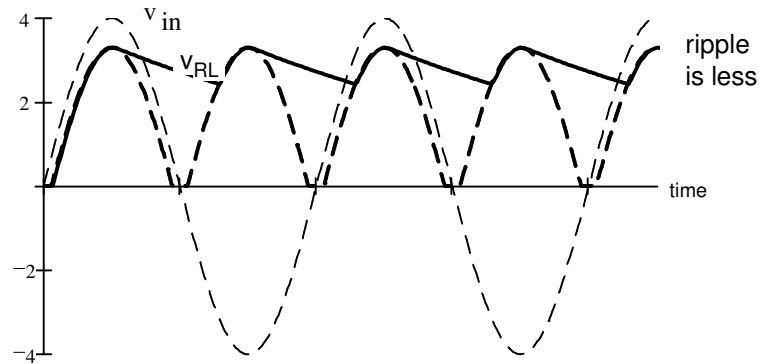

Bridge rectifiers are often drawn like this:

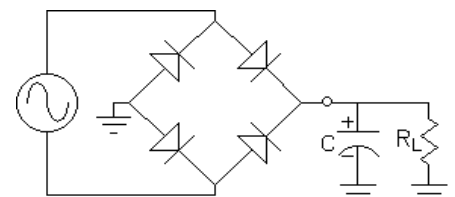

**Other Useful Diode Circuits**

Simple limiter circuits can be made with diodes. A common input protection to protect circuit from excessive input voltages such as static electricity.

The input to the box marked "sensitive circuit" can't get higher than the positive supply + 0.7V or lower than the negative supply - 0.7V.

Put a fuse in the  $V_{in}$  line and the diodes can make it blow, providing what's known as "crowbar" protection.

Another example of crowbar protection:

If the input voltage goes above 16 V. the fuse will blow, protecting the circuitry.

Or, If the input voltage is hooked up backwards the fuse will blow, protecting the circuitry.

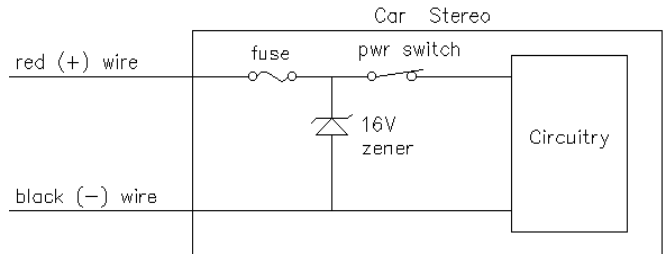
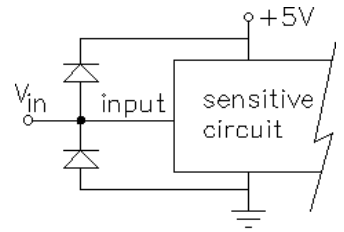

**AM detector**

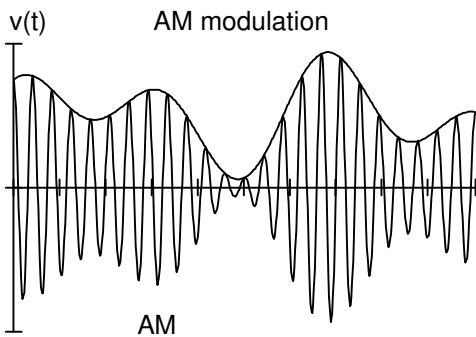

A simple rectifier circuit

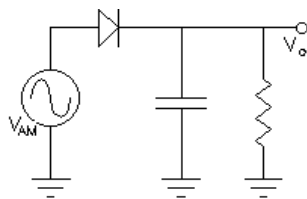

Returns the modulation signal

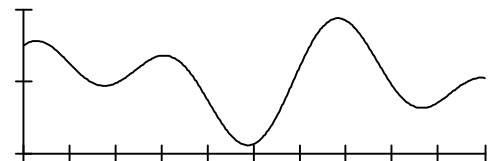

And a coupling capacitor can remove the DC

**Battery Isolator**

Like you might find in an RV. One alternator is used to charge two batteries. When the alternator is **not** charging, the batteries, the circuits they are hooked to should be isolated from one another. If not, then one battery might discharge through the second, especially if second is bad. Also, you wouldn't want the accessories in the RV to drain the starting battery, or your uncle George from South Dakota might never leave your driveway.

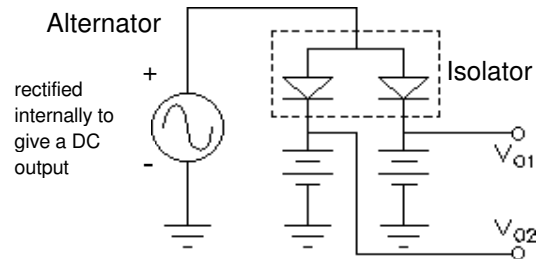

**Battery Backup Power**

Normally the power supply powers the load through D1. However, if it fails, the load will remain powered by the battery through D2. Finally, D3 and R may be added to keep the battery charged when the power supply is working. These sorts of circuits are popular in hospitals.

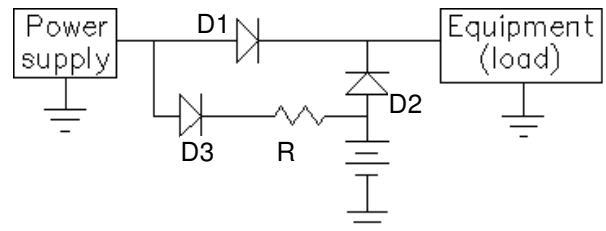

**Diode Logic Circuits**

Actually, both of the previous circuits are logic circuits as well.

"AND" gate

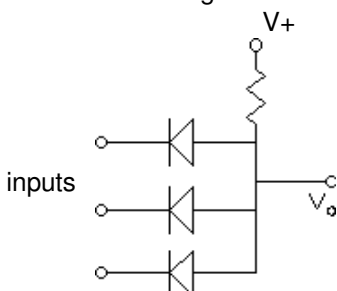

"OR" gate

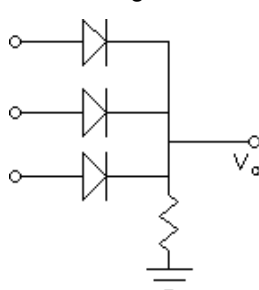

**"Flyback" Diode**

Every time the switch opens the inductor current continues to flow through the diode for a moment. If the diode weren't there, then the current would arc across the switch.

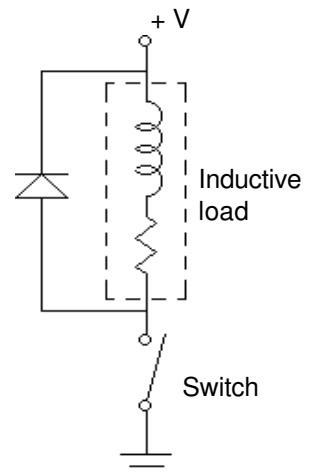

# ECE 2210 Diode Circuit Examples

## Basic diode circuit analysis

- 1 Make an educated guess about each diode's state.
- 2 Replace each diode with the appropriate model:
- 3 Redraw and analyze circuit.
- 4 Make sure that each diode is actually in the state you assumed:

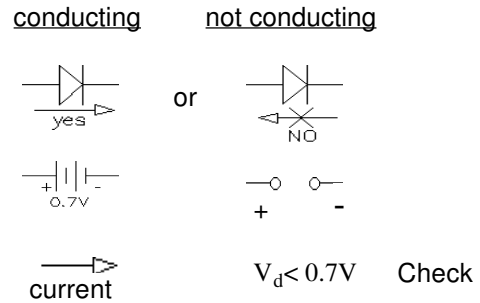

Note: 0.7V is for silicon junction diodes & will be different for other types. (2V for LED)

If any of your guesses don't work out right, then you'll have to start over with new guesses. In a circuit with  $n$  diodes there will be  $2^n$  possible states, all of which may have to be tried until you find the right one. Try to guess right the first time.

### Ex1

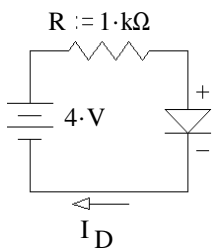

Try reverse-biased, non-conducting model

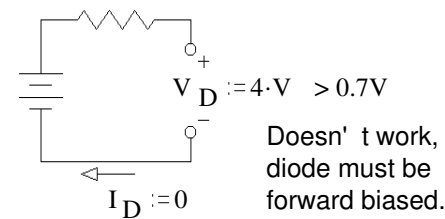

Try forward-biased, conducting model

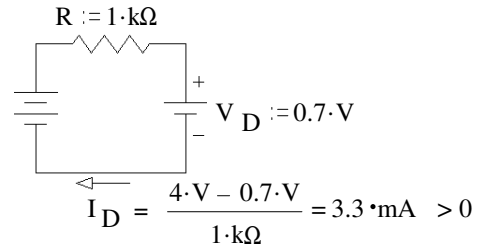

The current is in the forward direction, confirming the assumption.

### Ex2

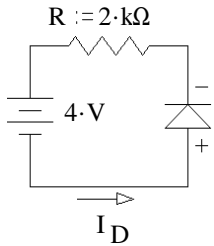

Try forward-biased, conducting model

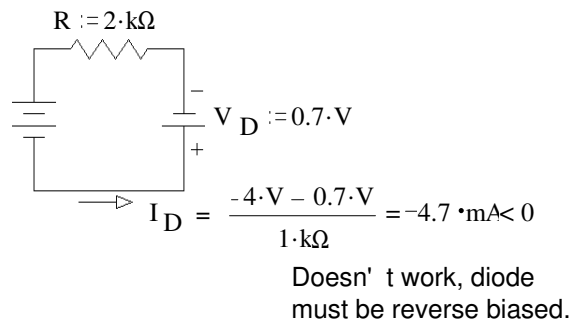

Try reverse-biased, non-conducting model

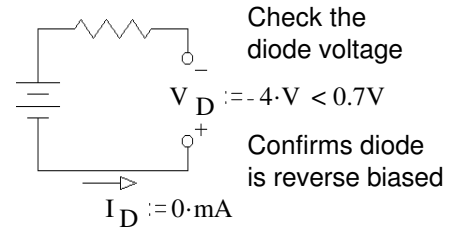

### Ex3

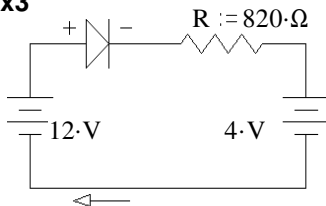

Try reverse-biased, non-conducting model

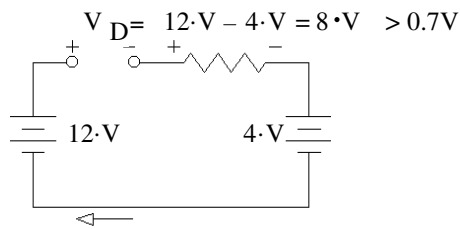

Try forward-biased, conducting model

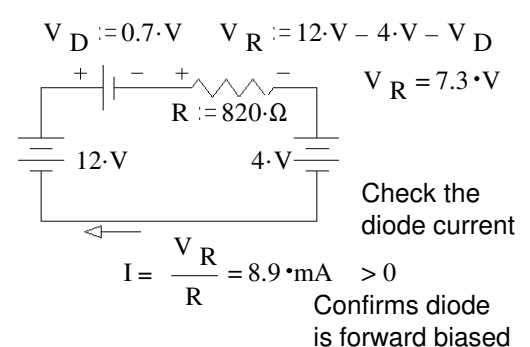

In each of these examples, my first guess was pretty stupid. I did that intentionally to show the process. I expect that you can make better guess and thus save yourself some work.

## ECE 2210 Diode Circuit Examples p2

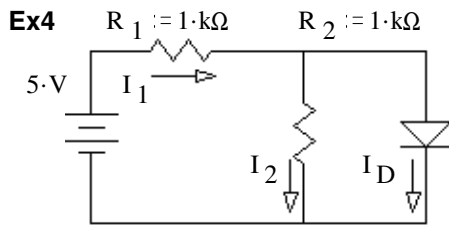

Assume diode conducts:  
Analyze

$$V_{R2} := V_D \quad I_2 := \frac{V_{R2}}{R_2}$$

$$I_2 = 0.7\text{ mA}$$

$$V_{R1} := 5\text{ V} - V_D \quad V_{R1} = 4.3\text{ V} \quad I_1 := \frac{V_{R1}}{R_1} \quad I_1 = 4.3\text{ mA}$$

We assumed conducting (assuming a voltage), so check the current.

$$I_D := I_1 - I_2 \quad I_D = 3.6\text{ mA} > 0, \text{ so assumption was correct}$$

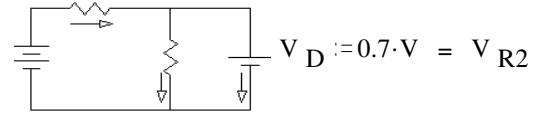

**Ex5** Now with an LED

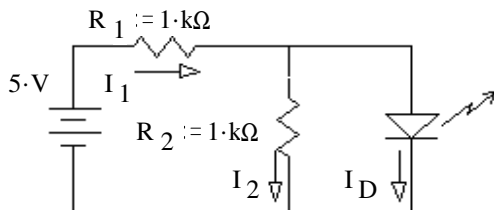

Assume diode conducts

Analyze

$$V_{R2} := V_D \quad I_2 := \frac{V_{R2}}{R_2}$$

$$I_2 = 2\text{ mA}$$

$$V_{R1} := 5\text{ V} - V_D \quad V_{R1} = 3\text{ V} \quad I_1 := \frac{V_{R1}}{R_1} \quad I_1 = 3\text{ mA}$$

We assumed conducting (assuming a voltage), so check the current.

$$I_D := I_1 - I_2 \quad I_D = 1\text{ mA} > 0, \text{ so assumption was correct, but the current is probably too small to create noticeable light}$$

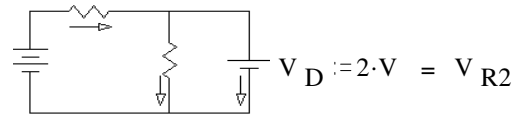

**Ex6** Regular diode, but smaller  $R_1$

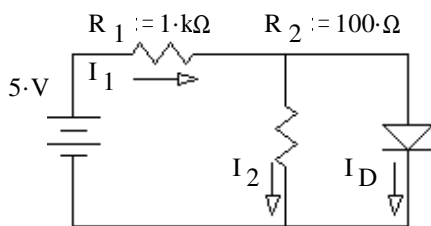

Assume diode conducts

Analyze

$$V_{R2} := V_D \quad I_2 := \frac{V_{R2}}{R_2}$$

$$I_2 = 7\text{ mA}$$

$$V_{R1} := 5\text{ V} - V_D \quad V_{R1} = 4.3\text{ V} \quad I_1 := \frac{V_{R1}}{R_1} \quad I_1 = 4.3\text{ mA}$$

We assumed conducting (assuming a voltage), so check the current.

$$I_D := I_1 - I_2 \quad I_D = -2.7\text{ mA} < 0, \text{ so assumption was } \mathbf{WRONG!}$$

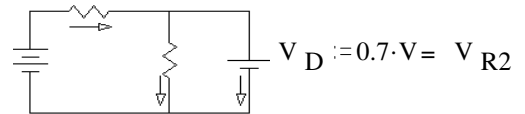

Assume diode does not conduct

$$I_D := 0\text{ mA}$$

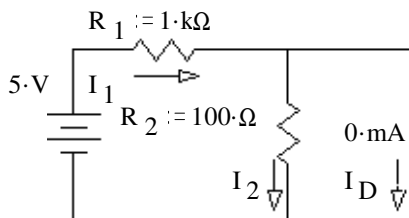

$$\text{Analyze} \quad I_1 := \frac{5\text{ V}}{R_1 + R_2} \quad I_2 := I_1$$

We assumed not conducting (assuming a current), so check the voltage.

$$V_{R2} := I_2 \cdot R_2 \quad V_{R2} = 0.455\text{ V} < 0.7\text{ V}, \text{ so assumption was correct}$$

Actually, this final check isn't necessary, since first assumption didn't work, so this one had to.

Ex7

ECE 2210 Diode Circuit Examples p3

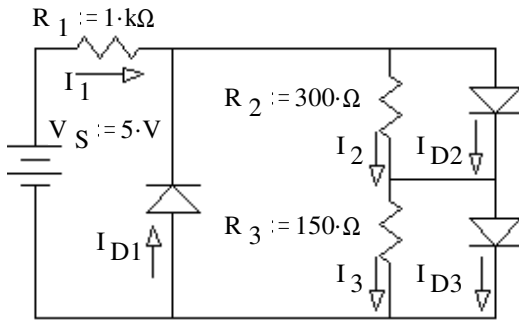

You can safely say that diode  $D_1$  doesn't conduct without rechecking later because no supply is even trying to make current flow through that diode the right way.

Assume both  $D_2$  and  $D_3$  conduct.

Analyze  $V_{R1} := V_S - V_{D2} - V_{D2}$   
 $V_{R1} = 3.6 \cdot V$

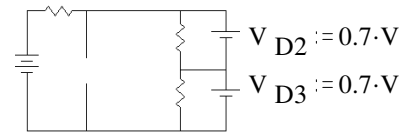

$$I_1 := \frac{V_{R1}}{R_1} \quad I_1 = 3.6 \cdot \text{mA}$$

$$I_2 := \frac{V_{D2}}{R_2} \quad I_2 = 2.333 \cdot \text{mA}$$

$$I_3 := \frac{V_{D3}}{R_3} \quad I_3 = 4.667 \cdot \text{mA}$$

We assumed  $D_1$  &  $D_2$  conduct (assumed a voltage), so check currents.

$$I_{D2} := I_1 - I_2 \quad I_{D2} = 1.267 \cdot \text{mA} > 0, \text{ so assumption OK}$$

$$I_{D3} := I_1 - I_3 \quad I_{D3} = -1.067 \cdot \text{mA} < 0, \text{ so assumption **wrong**}$$

Assume  $D_2$  conducts and  $D_3$  doesn't.

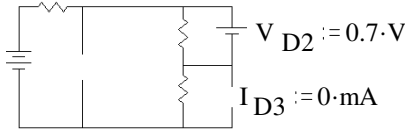

Analyze  $I_2 := \frac{V_{D2}}{R_2} \quad I_2 = 2.333 \cdot \text{mA}$

$$I_1 := \frac{V_S - V_{D2}}{R_1 + R_3} \quad I_1 = 3.739 \cdot \text{mA}$$

Assumed  $D_2$  conducts, so check  $D_2$  current.  $I_{D2} := I_1 - I_2 \quad I_{D2} = 1.406 \cdot \text{mA} > 0, \text{ so assumption OK}$

Assumed  $D_3$  doesn't conduct, so check  $D_3$  voltage.  $V_{R3} := I_1 \cdot R_3 \quad V_{R3} = 0.561 \cdot V < 0.7V, \text{ so OK}$

Once you find one case that works, you don't have to try any others.

Zener Diodes

Zener diodes are special diodes designed to operate in the reverse breakdown region. Since the reverse breakdown voltage across the diode is very constant for a large range of current, it can be used as a voltage reference or regulator. Diodes are not harmed by operating in this region as long as their power rating isn't exceeded. In the forward direction zeners work the same as regular diodes.

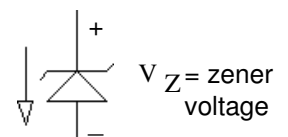

Now there are three possible regions of operation:

Same basic diode circuit analysis

- 1 Make an educated guess about each diode's state.
- 2 Replace each diode with the appropriate model:
- 3 Redraw and analyze circuit.
- 4 Make sure that each diode is actually in the state you assumed:

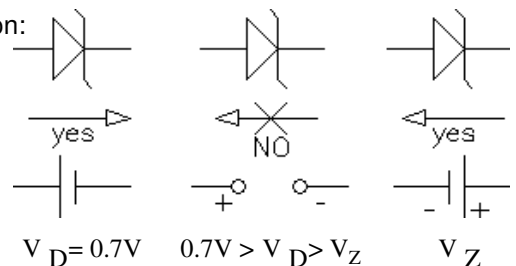

# Zener Diode Circuit Examples

Ex1 Typical shunt regulator circuit:

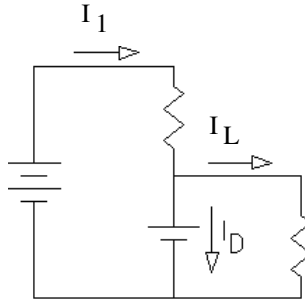
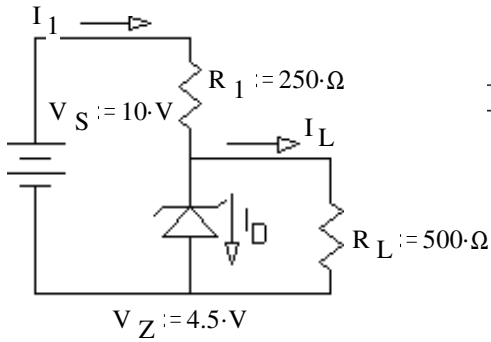

$$V_Z := 4.5 \cdot V \quad R_L := 500 \cdot \Omega$$

Assume conducting in breakdown region

$$V_D := V_Z$$

$$I_L := \frac{V_Z}{R_L} \quad I_L = 9 \cdot \text{mA}$$

$$I_1 := \frac{V_S - V_Z}{R_1} \quad I_1 = 22 \cdot \text{mA}$$

Assumed a conducting region, so check the current to see if the current flows in the direction shown.

$$I_D := I_1 - I_L \quad I_D = 13 \cdot \text{mA} > 0, \text{ so assumption OK}$$

Ex2 What if  $R_L$  is smaller?  $R_L := 150 \cdot \Omega$

Assume conducting in breakdown region

$$V_D := V_Z \quad I_L := \frac{V_Z}{R_L} \quad I_L = 30 \cdot \text{mA}$$

$$I_1 := \frac{V_S - V_Z}{R_1} \quad I_1 = 22 \cdot \text{mA} \quad I_D := I_1 - I_L \quad I_D = -8 \cdot \text{mA} < 0, \text{ so assumption is } \mathbf{WRONG!}$$

Circuit "falls out of regulation"

Assume not conducting

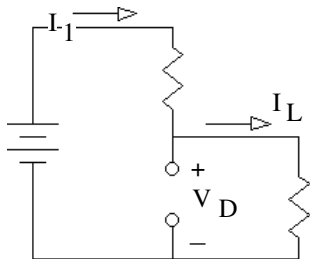

$$I_L = I_1 := \frac{V_S}{R_1 + R_L} \quad I_1 = 25 \cdot \text{mA}$$

Assumed a non-conducting region, so check the voltage to see if it's in the right range.

$$V_D := \frac{R_L}{R_1 + R_L} \cdot V_S \quad V_D = 3.75 \cdot V < V_Z = 4.5 \cdot V$$

so this assumption is OK

Ex3 What if  $V_S$  is smaller instead of  $R_L$ ?  $V_S := 6 \cdot V \quad R_L := 500 \cdot \Omega$

Assume conducting in breakdown region

$$V_D := V_Z \quad I_L := \frac{V_Z}{R_L} \quad I_L = 9 \cdot \text{mA}$$

$$I_1 := \frac{V_S - V_Z}{R_1} \quad I_1 = 6 \cdot \text{mA} \quad I_D := I_1 - I_L \quad I_D = -3 \cdot \text{mA} < 0, \text{ so assumption is } \mathbf{WRONG!}$$

Circuit "falls out of regulation"

Assume not conducting

$$I_L = I_1 := \frac{V_S}{R_1 + R_L} \quad I_1 = 8 \cdot \text{mA}$$

Assumed a non-conducting region, so check the voltage to see if it's in the right range.

$$V_D := \frac{R_L}{R_1 + R_L} \cdot V_S \quad V_D = 4 \cdot V < V_Z = 4.5 \cdot V$$

so this assumption is OK



Exam-type Diode Circuit Examples

On an exam, I usually tell you what assumptions to make about the diodes, then you can show that you know how to analyze the circuit and test those assumptions. Since everyone starts with the same assumptions, everyone should do the same work.

In the circuit shown, use the constant-voltage-drop model for the silicon diode.

- a) Assume that diode  $D_1$  does NOT conduct.  
Assume that diode  $D_2$  does conduct.

Find  $V_{R2}$ ,  $V_{R1}$ ,  $I_{R1}$ , &  $I_{D2}$ , based on these assumptions. Stick with these assumptions even if your answers come out absurd. Hint: think in nodal voltages.

$V_{R2} =$  \_\_\_\_\_  
 $V_{R1} =$  \_\_\_\_\_  
 $I_{R1} =$  \_\_\_\_\_  
 $I_{D2} =$  \_\_\_\_\_

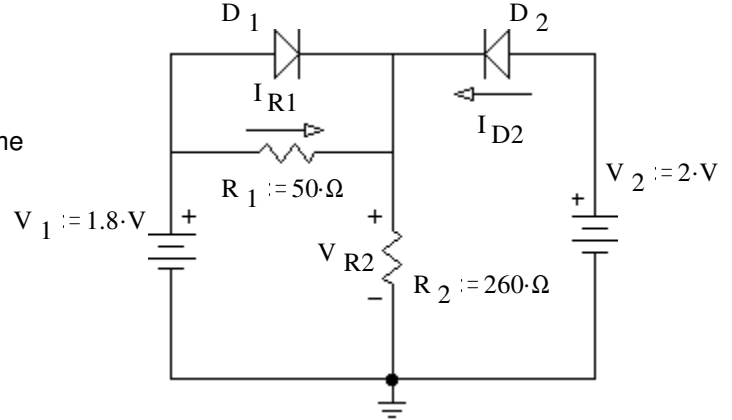

Solution to a)

$V_{R2} := V_2 - 0.7\text{V}$	$V_{R2} = 1.3\text{V}$
$V_{R1} := V_1 - V_{R2}$	$V_{R1} = 0.5\text{V}$
$I_{R1} := \frac{V_{R1}}{R_1}$	$I_{R1} = 10\text{mA}$
$I_{R2} := \frac{V_{R2}}{R_2}$	$I_{R2} = 5\text{mA}$
$I_{D2} := I_{R2} - I_{R1}$	$I_{D2} = -5\text{mA}$

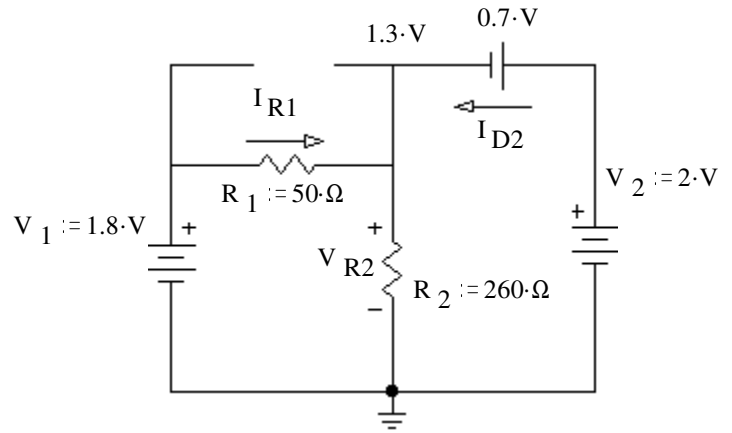

- b) Based on your numbers above, does it look like the assumption about  $D_1$  was correct? yes    no  
(circle one)  
How do you know? (Specifically show a value which is or is not within a correct range.)

yes     $V_{D1} = V_{R1} = 0.5\text{V} < 0.7\text{V}$

- c) Based on your numbers above, does it look like the assumption about  $D_2$  was correct? yes    no  
(circle one)  
How do you know?

no     $I_{D2} = -5\text{mA} < 0$

- d) Based on your answers to b) and c), which (if any) of the following was not correctly calculated in part a.

$V_{R2}$        $V_{R1}$        $I_{R1}$        $I_{D2}$

(circle any number of answers)

Circle all in this case

Assume that diode  $D_1$  is conducting and that diode  $D_2$  is not conducting.

- a) Find  $V_{R1}$ ,  $I_{R1}$ ,  $I_{R3}$ ,  $I_{D1}$ ,  $V_{R2}$  based on these assumptions.  
Do not recalculate if you find the assumptions are wrong.

$V_{R1} =$  \_\_\_\_\_

$I_{R1} =$  \_\_\_\_\_

$I_{R3} =$  \_\_\_\_\_

$I_{D1} =$  \_\_\_\_\_

$V_{R2} =$  \_\_\_\_\_

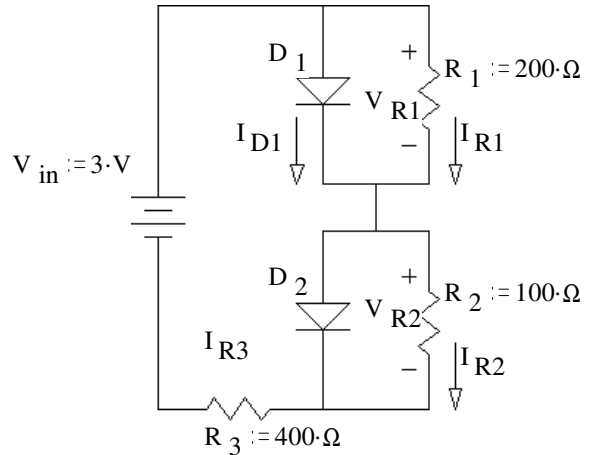

Solution:

$V_{R1} := 0.7 \cdot V$

$I_{R1} := \frac{V_{R1}}{R_1}$

$I_{R3} := \frac{V_{in} - 0.7 \cdot V}{R_2 + R_3}$

$I_{D1} := I_{R3} - I_{R1}$

$I_{R2} := I_{R3}$

$V_{R2} := I_{R2} \cdot R_2$

$I_{R1} = 3.5 \cdot \text{mA}$

$I_{R3} = 4.6 \cdot \text{mA}$

$I_{D1} = 1.1 \cdot \text{mA}$

$V_{R2} = 0.46 \cdot V$

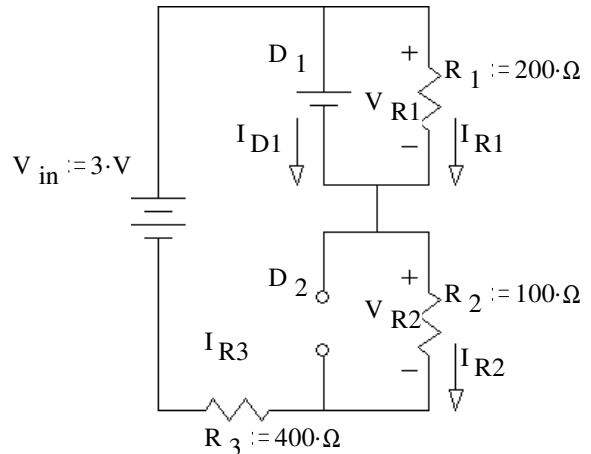

- b) Was the assumption about  $D_1$  correct? (circle one)  
yes no

How do you know? (Specifically show a value which is or is not within a correct range.)

yes  $I_{R2} = 4.6 \cdot \text{mA} > 0$

- c) Was the assumption about  $D_2$  correct? (circle one)  
yes no

How do you know?

yes  $V_{D2} = V_{R2} = 0.46 \cdot V < 0.7V$

- d) Based on your answers to b) and c), which (if any) of the following was not correctly calculated in part a.

$V_{R1}$        $I_{R1}$        $I_{R3}$        $I_{D2}$        $V_{R2}$

(circle any number of answers)

Circle none in this case

## ECE 2210 Diode Circuit Examples p7

A voltage waveform (dotted line) is applied to the circuit shown.  
Accurately draw the output waveform ( $v_o$ ) you expect to see.  
 Label important times **and** voltage levels.

If diode doesn't conduct:

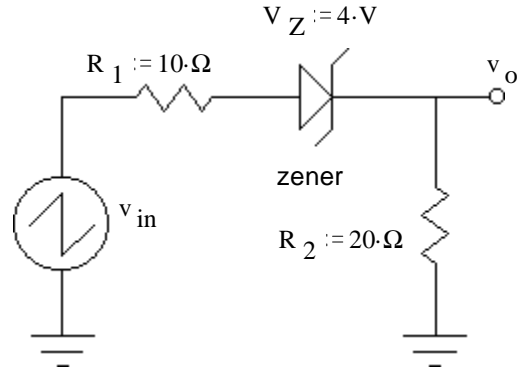
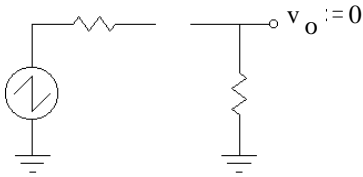

Positive half

Diode conducts at:  $0.7\text{-V}$  input      at time:  $\frac{0.7\text{-V}}{10\text{-V}} \cdot 10\text{-ms} = 0.7\text{-ms}$

Maximum:

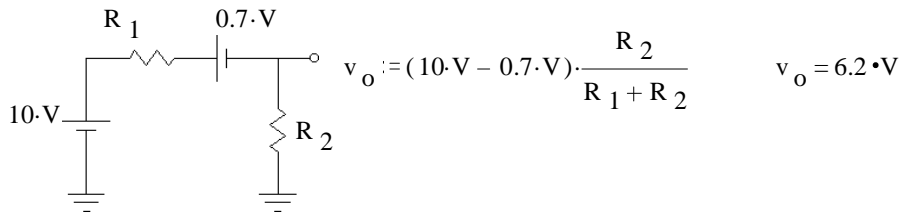

Negative half

Diode conducts at:  $-4\text{-V}$  input      at time:  $20\text{-ms} - \frac{4\text{-V}}{10\text{-V}} \cdot 10\text{-ms} = 16\text{-ms}$

Maximum:

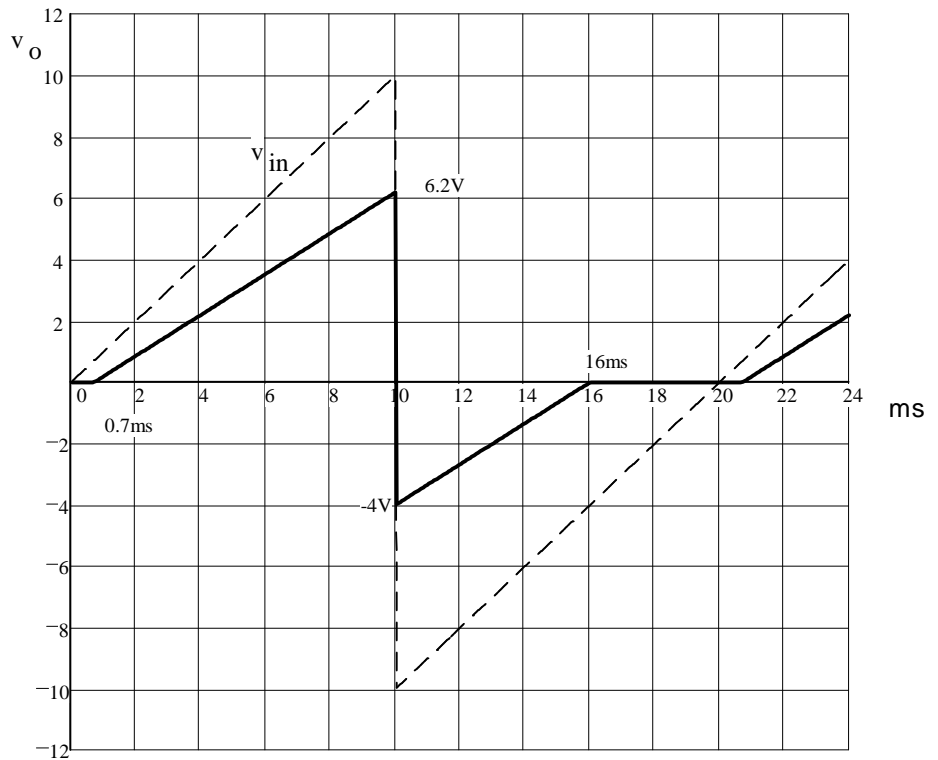
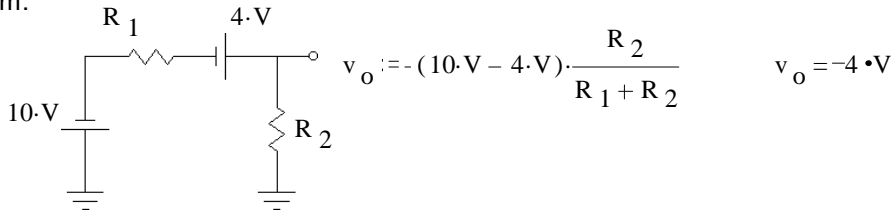

A voltage waveform (dotted line) is applied to the circuit shown. Accurately draw the output waveform ( $v_o$ ) you expect to see. Label important times and voltage levels.

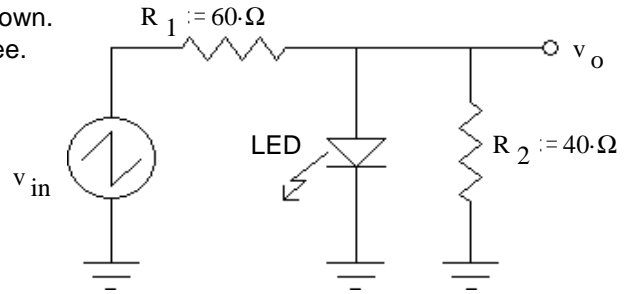

If diode doesn't conduct:

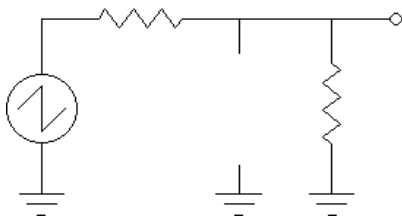

$$v_o = \frac{R_2}{R_1 + R_2} \cdot v_{in}$$

$$\frac{R_2}{R_1 + R_2} \cdot 10 \cdot V = 4 \cdot V$$

When:  $v_{in} := \frac{R_1 + R_2}{R_2} \cdot 2 \cdot V$        $v_{in} = 5 \cdot V$       at: 5-ms      Diode begins to conduct

When diode conducts:

