

ECE1050 Final given: Fall 02

(The space between problems has been removed.)

1. (11 pts)

a) Find and draw the Thévenin equivalent of the circuit shown. The load resistor is R_L .

b) Find and draw the Norton equivalent of the same circuit.

c) Find the power dissipated by the load.

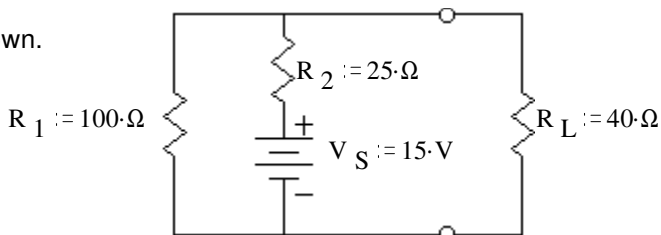

2. (16 pts) a) Use the method of superposition to find the voltage across R_3 . Be sure to clearly show and **circle** your intermediate results.

b) Show the polarity of this voltage on the drawing.

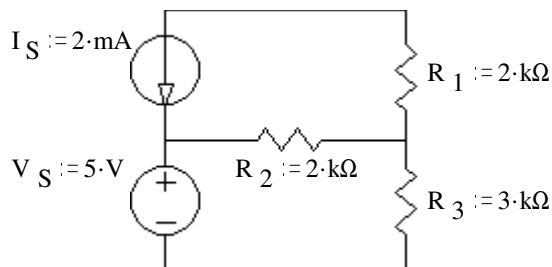

3. (22 pts) a) Draw the asymptotic Bode plot (the straight-line approximation) of the filter circuit below. Accurately draw it on the graph provided. V_{in} is the input and V_R is the output of this circuit.

To be eligible for partial credit, show the steps you use to get the Bode plot. That is, show things like the transfer function, the corner frequency(ies) , the approximations of the transfer function in each frequency region, etc..

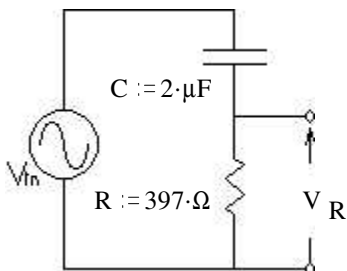

Magnitude plot
 $|H(f)|$

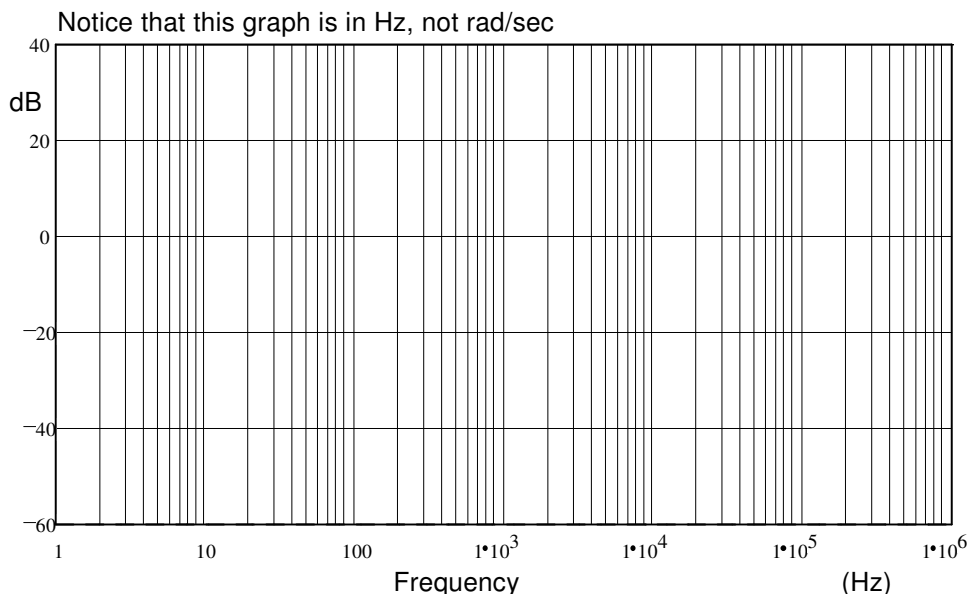

b) The asymptotic Bode plot is not exact. The actual magnitude of the transfer function can be a little different than the straight-line approximation. Fill in the blanks in the line below.

The actual magnitude is _____ dB higher lower than the Bode plot at twice the corner frequency.

(Circle one)

ECE1050 Final given: Fall 02 p2

4. (12 pts) The transformer shown in the circuit below is ideal. Find the following:

a) $V_2 = ?$

b) The power dissipated by R_2 . $P_2 = ?$

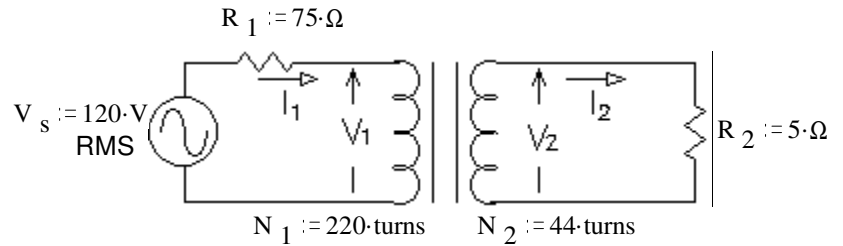

5. (22 pts) In the circuit shown, use the constant-voltage-drop model for the silicon diode.

a) Assume that diode D_1 does NOT conduct.

Assume that diode D_2 does conduct.

Find V_{R2} , V_{R1} , I_{R1} , & I_{D2} , based on these assumptions. Stick with these assumptions even if your answers come out absurd. Hint: think in nodal voltages.

$V_{R2} =$ _____

$V_{R1} =$ _____

$I_{R1} =$ _____

$I_{D2} =$ _____

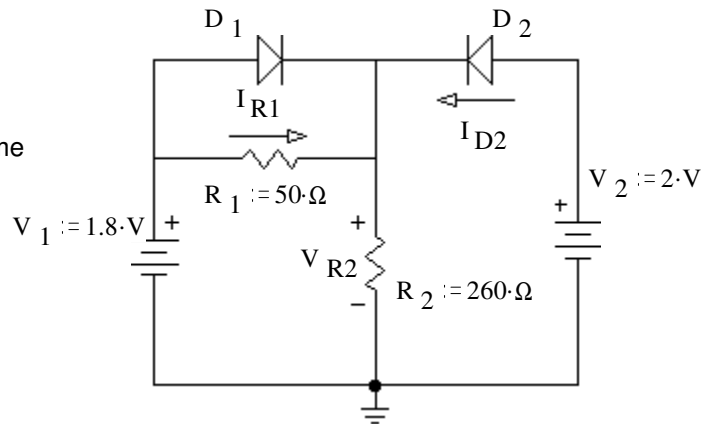

b) Based on your numbers above, does it look like the assumption about D_1 was correct?

yes no

How do you know? (Specifically show a value which is or is not within a correct range.)

(circle one)

c) Based on your numbers above, does it look like the assumption about D_2 was correct?

yes no

How do you know?

(circle one)

d) Based on your answers to b) and c), which (if any) of the following was not correctly calculated in part a.

V_{R2} V_{R1} I_{R1} I_{D2}

(circle any number of answers)

6. (16 pts) A voltage waveform (dotted line) is applied to the circuit shown. Accurately draw the output waveform (v_o) you expect to see. Use the constant-voltage-drop model for LED. Label important times and/or voltage levels.

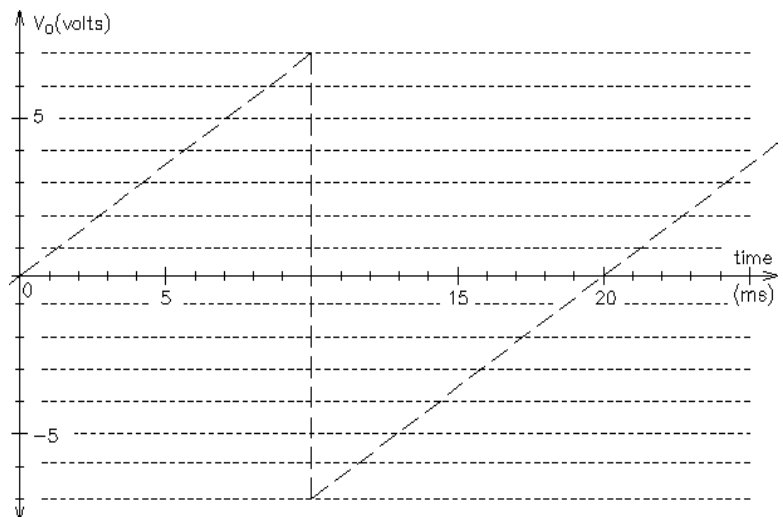
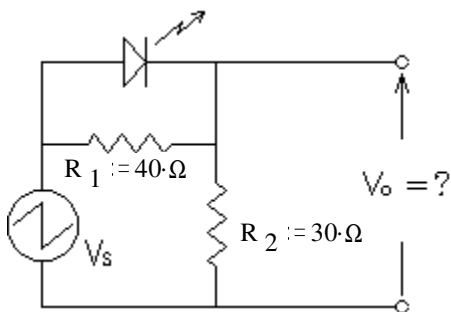

ECE1050 Final given: Fall 02 p3

7. (40 pts) You have two input voltages to work with. The waveform (at right) and a 1V battery.

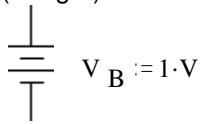

The problems below are op-amp design problems. The answer should be a schematic of a circuit showing the values of all the parts. Use reasonable resistor values (in the 100Ω to $1\text{ M}\Omega$ range).

a) Design a circuit which will output the waveform at right.

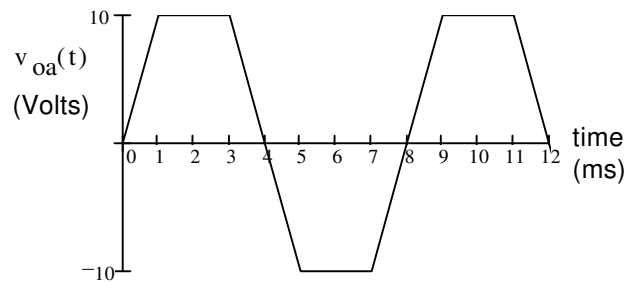
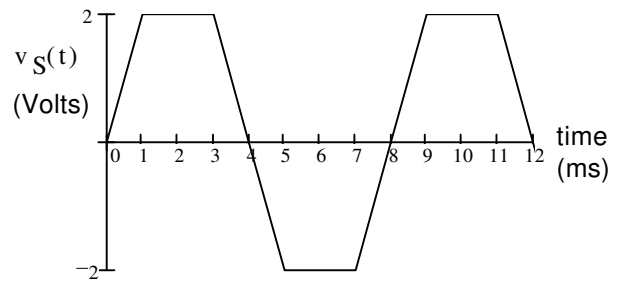

b) Design a circuit which will output the waveform at right.

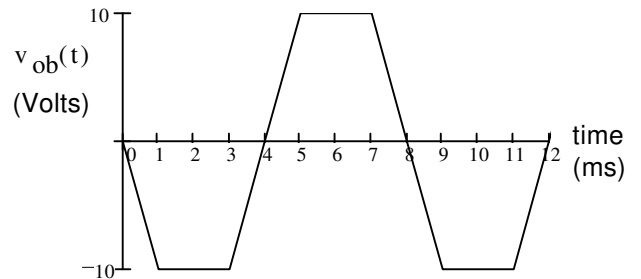

c) Design a circuit which will output the waveform at right.

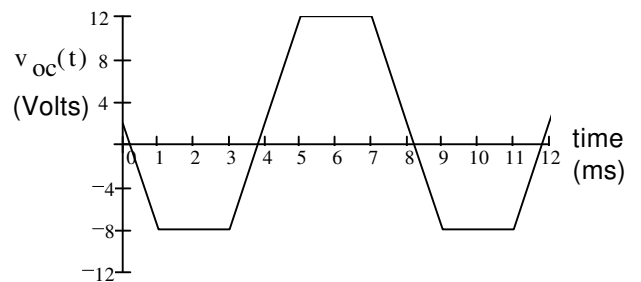

d) Design a circuit which will output the waveform at right. Hint: Think differentiation & look up equation in op-amp notes handout.

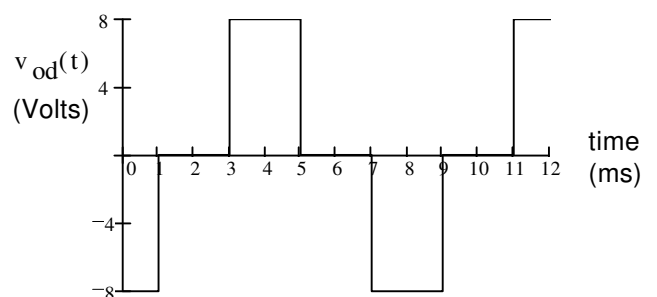

ECE1050 Final given: Fall 02 p4

8. (30 pts) Fill in the blanks in the circuit.
You may neglect I_B (assume that it's 0).

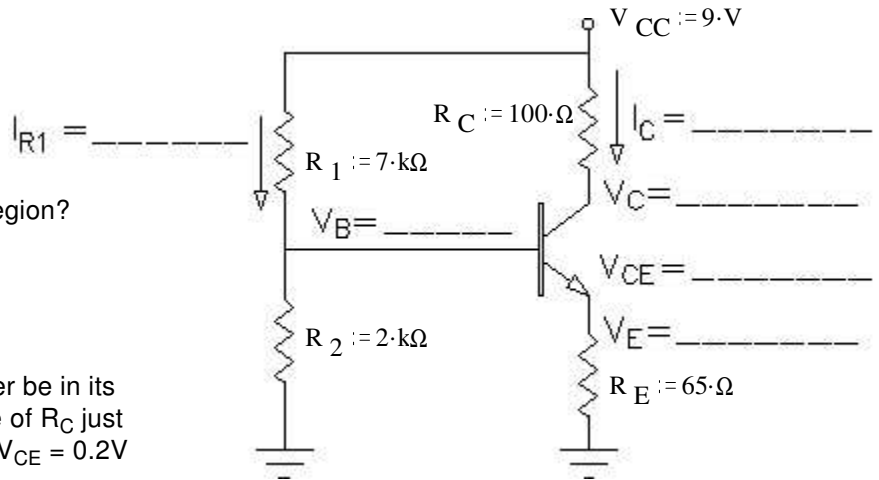

b) Is the transistor operating in the active region?

Yes No (circle one)

Show your evidence.

c) If R_C is too big the transistor will no longer be in its active region and will saturate. What value of R_C just begins to cause saturation? Hint: Assume $V_{CE} = 0.2V$ and find the R_C that would cause that.

d) If the some components were added so that you could add an AC signal at the base, an AC signal would also appear at the collector. What signal gain do you expect to see?

$$\frac{v_o}{v_s} = ?$$

e) How could you improve this gain? Add the appropriate component in the appropriate place in the circuit at right.

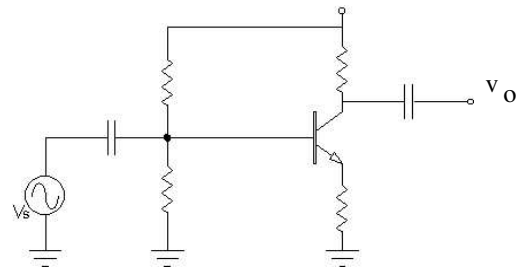

f) $\beta = 180$ Use the value of I_C that you calculated above to approximate the value of I_B (previously neglected).

g) Compare this value to I_{R1} . Was it reasonable to neglect I_B ? (is $I_B < 10\%$ of I_{R1}) Yes No (circle one)

9. Do you want your grade and scores posted on my door and on the Internet? Yes No (Circle one)

If your answer is yes, then provide some sort of alias or password: _____

The grades will be posted on my door in alphabetical order under the alias that you provide here. I will not post grades under your real name. The Internet version will be an excel spreadsheet which you can download. Both will show all your homework, lab, and exam scores.

Answers

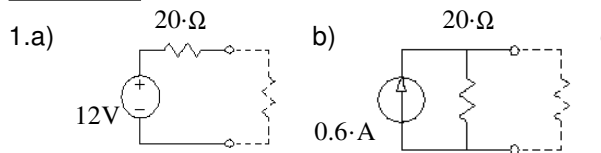

c) 1.6W

2.a) $3 \cdot V - 2.4 \cdot V = 0.6 \cdot V$ b) positive on top

3.b) The actual magnitude is 1 dB lower than the Bode plot at twice the corner frequency.

3. Magnitude plot $|H(f)|$
Straight-line approximation _____
Actual _____
(not required)

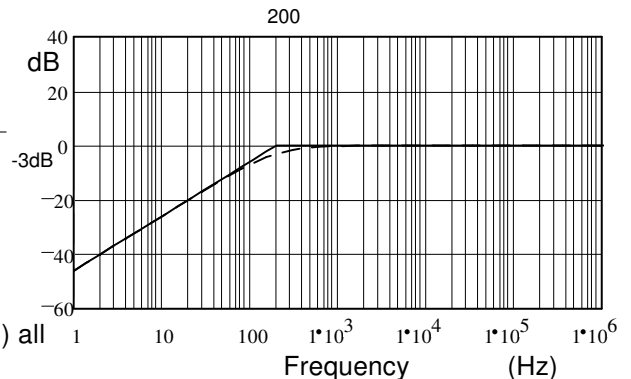

4.a) 15V b) 45W

5.a) 1.3V, 0.5V, 10mA, -5mA b) yes, $V_{D1} < 0.7V$ c) no, $I_{D2} < 0mA$ d) all

6. straight lines between the following points: (0,0), (5ms,1.5V), (10ms,5V), (10ms,-3V), (20ms,0V), repeat.

7.a) non-inverting amp with $R_f = 4R_1$ b) inverting amp with $R_f = 5R_1$ c) summer with $R_f = 5R_1$ & $R_f = 2R_2$ battery - terminal is hooked to R_2 and + to ground d) differentiator with $R_f = 8V/(C(2000V/s))$

8.a) $V_B = 2V$, $I_{R1} = 1mA$, $V_E = 1.3V$, $I_C \approx I_E = 20mA$, $V_C = 7V$, $V_{CE} = 5.7V$ b) yes, $V_{CE} > 0.2V$ c) 375Ω

d) 1.54 e) place a cap from emitter to ground f) 0.111mA